

How to build your own hyperspectral camera

Katherine Salesin, Dario Seyb, Sarah Friday, and Wojciech Jarosz



1 INTRODUCTION

This document provides detailed instructions in order to set up and perform the experiments described in the paper “DIY hyperspectral imaging via polarization-induced spectral filters.” Sec. 2 describes how to prepare the polarizers and waveplates for use in experiments. Sec. 4 describes how to prepare the mosaic grid of waveplates. Sec. 3 describes how to perform the calibration procedure in order to estimate the birefringence of your birefringent material. This must be performed once per unique material. Finally, Sec. 5 describes how to perform retrievals of real-world reflectance spectra using the prepared polarizers and waveplates. This should allow you to perform the types of experiments used to generate Figures 7 and 8 in the paper.

2 PREPARING THE FILTERS

Materials needed:

- Linear polarizer (at least two): a linear polarizing filter of the same diameter as your camera lens. Be careful not to buy a *circular* polarizing filter, which are more common for photography.
- Birefringent material (at least two): any birefringent material will do, whether that is clear packing tape, a waveplate polymer film, or crystal. You will ideally want to choose a material with a high birefringence value, which will produce more expressive transmission spectra – we found when comparing tapes vs. cheap waveplate polymer films that the tapes had higher birefringences. Also, be aware that some optical-grade waveplates (e.g. achromatic waveplates) consist of multi-layered materials in order to produce a consistent retardance across wavelengths, which is counterproductive to this application. Note that matte finish tape (e.g. Scotch Magic Tape) will *not* work for this purpose. We chose two different clear packing tapes whose thicknesses were reported by the manufacturer.
- Clear filter (at least two): a neutral clear filter of the same diameter as your camera lens that has no effect on the image (typically used as a layer of protection for the lens). A UV filter will not work for this purpose since it may have a visible effect on the image.
- Sticker printer paper (optional): to print out angle labels that can be easily attached to the filters

Summary:

1. Affix the birefringent materials to the clear filters.
2. Label the angles of the linear polarizers and clear filters.

2.1 Affixing the birefringent material to the clear filter

Affix the clear filter to a paper or cutting mat with a grid marked on it. Try to align the filter such that it is centered on two grid lines perpendicular to one another. Find the fast axis of the birefringent material. For clear packing tape, this is perpendicular to the length of the tape. Affix the tape neatly to the clear filter, aligning the edges of the tape to straight lines on the grid as best you can, and squeeze out any air bubbles with a credit card or other makeshift squeegee. Mark the fast axis angle on the outer edge of the clear filter – this should be where one of the centered grid lines touches the outer edge of the filter. Whether you mark one of these intersections or the one opposite (essentially marking which is 0° and which is 180°) does not matter. This clear filter with a birefringent material attached will henceforth be referred to as a “waveplate.”

- K. Salesin, D. Seyb, S. Friday, and W. Jarosz are with Dartmouth College, Hanover, NH, USA.
E-mail: katherine.a.salesin.gr@dartmouth.edu

2.2 Labeling the angles

We found the most effective way to mark the angles was to print a sticker with the angles labeled in 5° increments. Measure the diameter d of your filters at their widest point to the nearest mm. The advertised “diameter” of the filters is the diameter of the inner threads, whereas you need the diameter of the outermost edge. In our case, the advertised diameter was 52 mm and our measured diameter d was 54 mm. Then the circumference C of your filters is πd . Also measure the width of the outer ring w , which gives you the other dimension of your labels (for us, this was 3–4 mm). In your design software of choice, make a rectangle of size $C \times w$ and mark angle ticks and labels in evenly spaced 5° intervals. Print the labels on sticker paper and affix to filters, aligning 0° with the fast axis mark in the case of waveplates or the axis of polarization in the case of linear polarizers. The polarizing axis was marked with a little triangle on our polarizing filters; if yours are not marked, you can find the axis of polarization using a known reference such as polarized sunglasses or the LCD on a laptop.

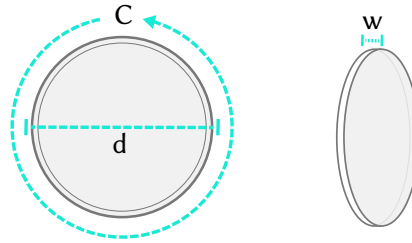

3 PERFORMING THE BIREFRINGENCE CALIBRATION

The birefringence calibration must be performed once per unique birefringent material (in our case, two times since we used two different types of tape).

Materials needed:

- Prepped linear polarizers and waveplates from Sec. 2
- Digital camera: a sensor that responds linearly to incident light. Any camera designed for casual photography will do as long as it has threads where filters can screw into the lens (therefore, a cell phone camera will not do). Ideally, the sensor responses of the camera should be known; there are several databases online where one can find or estimate the sensor responses of typical consumer cameras [1].
- Laser pointers (at least three of distinct wavelengths): laser pointers of sufficient brightness with reported wavelengths (consumer laser pointers are typically only manufactured in a small handful of wavelengths). We chose a red (650 nm), a green (532 nm), and a violet (405 nm) laser pointer. We recommend going a tier above the cheapest cat toy or presentation laser pointers, which are likely too dim, in favor of laser pointers intended for astronomy or other hobbies (these are still relatively cheap at <\$20 each).
- Vellum or other diffuser: a translucent sheet or film to spread out the laser beam point.
- Remote trigger for camera (optional): for minimal camera movement when taking a measurement. Many modern cameras with built-in Wi-Fi will connect to apps that have a remote trigger function.

Summary:

1. Set up the camera, laser, and diffuser.
2. Take a series of measurements with the waveplate held steady at 45° and the analyzer rotating in 5° increments. Repeat for each laser.
3. Process results with the method of [2].

3.1 Setting the scene

Set the camera and laser so that they face each other. We found it most effective to use an adjustable tripod for the camera, a microphone stand for the laser, and set the entire experiment on a table. The camera and laser height could also be adjusted using books or other available objects. Place the diffuse material between the laser and camera at a distance that suitably diffuses the laser beam point (we taped a sheet of vellum to a cardboard box with a face cut out to allow the light to pass through). Next, screw the filters onto the camera lens, in order from the lens outward: polarizer (the “analyzer”), waveplate, polarizer (which we will call the “reference polarizer” to avoid confusion with the analyzer). All angles of rotation are defined relative to the 0° mark on the reference polarizer. Firmly hold the laser button in the “on” position using tape.

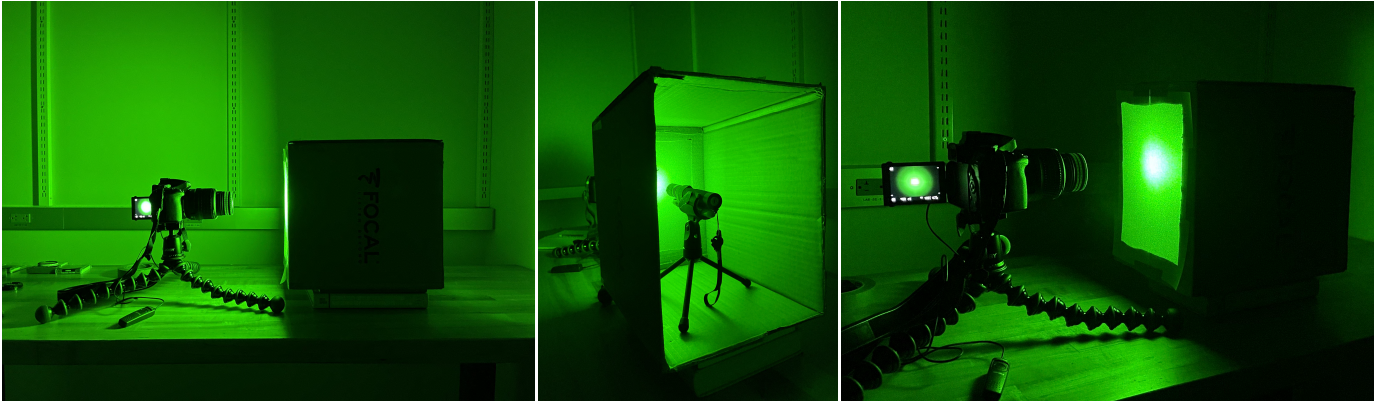

Fig. 1: Physical setup of the camera and laser pointer. *Left*: the experiment set up from the side. *Middle*: the laser pointer inside of a box holding the diffuse material. *Right*: the camera pointed at the laser, with the beam centered in the viewport

Center the laser beam within the camera viewport by adjusting either the height of the camera or laser setup. With the focus set to “auto,” focus the camera on the diffusing plane (it helps to hold a piece of paper with visible text directly on top of the diffuser). Place the focus setting to “manual,” and carefully secure the lens using tape: hold the focus ring of the lens steady and secure the barrel in place with tape. This step ensures the camera will stay in focus even when adjusting the filter angles, since the camera will not be able to autofocus in the dark.

When taking measurements, there must be no other sources of light in the room, even light sneakily creeping in from under a door. This of course will make it difficult to see the angle labels on the filters; we suggest using a flashlight, headlamp, or phone light to help set the angles in between measurements.

3.2 Taking measurements

Find the right exposure. Finding a proper exposure time is critical for these measurements. The exposure should ideally be set such that the maximum pixel value for any channel is not exceeded, but pixel values are high enough to minimize the effects of noise on the measurements. This exposure level *must* be consistent within a set of measurements for a single laser, but can be set differently per laser, since it is only the measured intensity relative to the incident intensity of light that matters. Some cameras have a live histogram feature that may be helpful here; otherwise, some guess-and-check may be necessary.

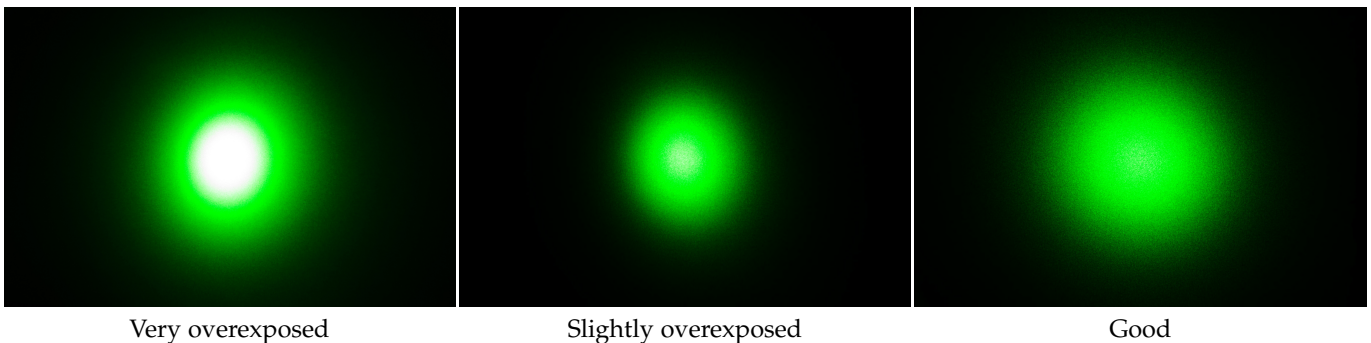

Fig. 2: Images with varying levels of overexposure

Make sure the camera is set to take RAW photos! Not JPEGs, which break the assumption of linearity in image formation.

Take a set of measurements. The method of [2] takes advantage of the linear relationship between measured intensity and the angle of the analyzer when the waveplate is oriented at 45° . Rotate the waveplate to 45° relative to the reference polarizer, rotating counterclockwise as you face the incoming light. Set the analyzer to 0° relative to the reference polarizer. Take a photo. Rotate the analyzer to 5° relative to the reference polarizer. Take a photo. Repeat this process, rotating the analyzer in 5° increments and keeping the waveplate steady at 45° relative to the reference polarizer, until you have taken a final photo with the analyzer at 180° . You should have 37 measurements total.

Switch out this laser for another color, and repeat this measurement process for however many distinct lasers you have.

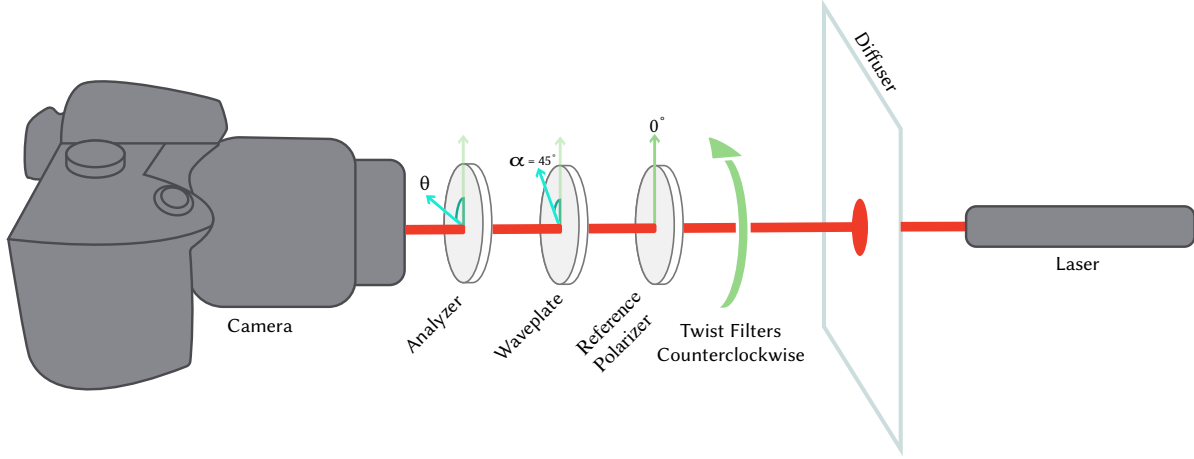

Fig. 3: Stack the filters in order of analyzer, waveplate, and polarizer. Rotate the waveplate to 45° counterclockwise to the reference polarizer. Rotate the analyzer in 5° increments counterclockwise to the reference polarizer when taking measurements.

3.3 Processing the results

The phase shift Γ induced by the waveplate is a function of the material's birefringence Δn , thickness d , and the wavelength of light λ :

$$\Gamma = \frac{2\pi}{\lambda} \Delta n d \quad (1)$$

Although birefringence Δn is the quantity we are ultimately interested in, we will use our measurement photos to first solve for Γ and then use Eq. (1) to solve for Δn .

Using Jones calculus (an alternative framework for describing polarized light), [2] relate the phase shift Γ and analyzer angle θ to measured intensity when the waveplate is at 45° by this simple formula:

$$I = \frac{1}{2} I_0 (1 + \cos \Gamma \cos 2\theta). \quad (2)$$

This is a linear relation of the form $y = mx + n$, where the slope m is $\frac{1}{2} I_0 \cos \Gamma$ and the intercept n is $\frac{1}{2} I_0$. Finding m and n requires simply doing a linear regression on our obtained measurements with $x = \cos(2\theta)$ and $y = I$, the measured intensities. We defined this intensity in practice by taking the 90th percentile of pixel values in each photo for the dominant channel (red channel for the red laser, etc.). Then, we solve for $\cos \Gamma$ given the best-fit m and n by $\cos \Gamma = m/n$.

At this point, it seems obvious to solve for Γ by $\Gamma = \cos^{-1}(\cos \Gamma)$. In practice, this would actually give us the smallest possible Γ , which we call Γ_1 . Given the cyclic nature of cosines, Γ could be any of the following:

$$\Gamma = 2\pi N \pm \Gamma_1, \quad 0 \leq \Gamma_1 \leq \pi, \quad (3)$$

where N is a non-negative integer. To resolve this ambiguity, we revisit Eq. (1). If the thickness d and birefringence Δn of the material are constants¹, then there is a simple inverse relationship between wavelength λ and phase shift Γ :

$$\frac{\Gamma_j}{\Gamma_i} = \frac{\lambda_i}{\lambda_j}, \quad i, j \in \{\text{violet, green, red}\}, \quad (4)$$

$$\text{and } \Gamma_{\text{violet}} > \Gamma_{\text{green}} > \Gamma_{\text{red}}, \quad (5)$$

using our chosen laser wavelengths as examples. In practice, we find the ratios $\lambda_{\text{violet}}/\lambda_j$ for $j \in \{\text{violet, green, red}\}$ and then find the appropriate Γ_j for $j \in \{\text{violet, green, red}\}$ among the options given by Eq. (3) such that Eq. (4) and Eq. (5) are satisfied.

Lastly, given Γ_j for each wavelength, we can solve for the best-fit birefringence Δn by least squares using Eq. (1).

1. Technically, there is a small dependence of birefringence on wavelength, but it is negligible in this context [2].

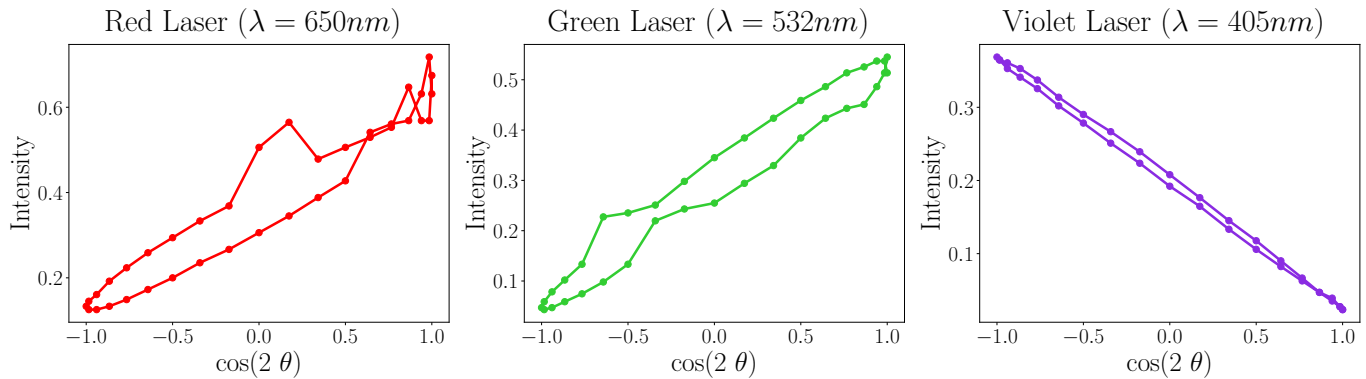

Fig. 4: Measurements of $\cos(2\theta)$ vs. intensity from our own calibration measurements of the Sure Start tape. In theory, there should be a perfect linear relationship. Clearly, these have slightly ellipsoidal shapes, which suggests that either the labeled axis of polarization on the linear polarizer or the fast axis of the waveplate may be slightly off from prediction. See [2] for further discussion.

4 CREATING A MOSAIC FILTER

Materials needed:

- Birefringent material (at least two): see above
- Clear filter (one): see above
- Protractor
- Graph paper: of the desired square size for the “tiles” in your mosaic; we used graph paper with 1/4” squares to create a 3×3 grid on our mosaic filter.
- Vellum or clear plastic: any translucent sheet from which the tape can be removed cleanly
- X-Acto knife
- Tweezers

Summary:

1. Create a guide for the desired angles on graph paper.
2. Rotate tape to desired angle, cut a square, and affix to clear filter.
3. Repeat to create grid.

4.1 Creating guides

Create an angle guide with the protractor and graph paper. Trace a bold line along one of the grid lines toward the center of the page to mark $0^\circ / 180^\circ$. From here, there a couple of ways you can go about making a guide: you can either mark angles in evenly spaced increments of 5 degrees and estimate the exact angles you need from that, or mark the exact angles you will need. We found it easiest to do both. Line up the protractor straight guide along the $0^\circ / 180^\circ$ line with the center hole aligned with some perpendicular grid line toward the center – mark inside the center hole to provide a reference for later. Keeping the protractor steady, mark with a dot and label the desired angles along the protractor curved edge. With a ruler or other straight edge, connect the angle marks to the center mark.

Create a tape guide with the tapes and translucent paper/plastic. The purpose of the translucent paper/plastic is to easily align the tape to the proper angles without having to stick tape to the angle guide itself. It should be translucent enough that you can see the lines and labels of the angle guide through it. When the tape is adhered to the paper/plastic, it should be easy to peel off without causing either the tape or paper/plastic to tear or leave any residue.

Align one edge of the paper/plastic with the $0^\circ / 180^\circ$ line on the angle guide. Affix the tape to the paper/plastic, carefully aligning the edge of the tape with grid lines running *perpendicular* to the $0^\circ / 180^\circ$ line – this is because the fast axis of the tape is perpendicular to the edges of the tape. Therefore, when you rotate the paper/plastic to align that edge with a new angle, the fast axis of the tape will be set at that angle as well. Do this for however many tapes you have (they can be on the same sheet of paper/plastic).

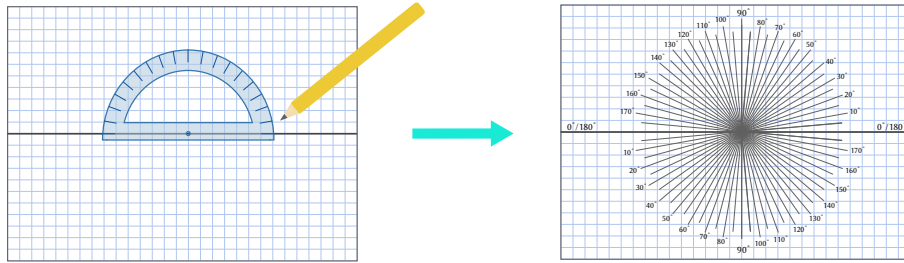

4.2 Creating the mosaic

Be careful about ordering! At this point, you will need to decide which tape to lay down on your clear filter first. Say that your filter choice algorithm gives you a set of 9 filter configurations, where each filter is comprised of: reference polarizer, waveplate 1, waveplate 2, and analyzer, in order of light traversal. Let us assume that the order of waveplate 1 and waveplate 2 is always consistent for every filter configuration (which is what we did in practice, since this eliminates the need to shuffle the waveplate filters in the middle of taking measurements). If you were setting this system up with single-waveplate filters, you would screw them into the camera lens in the opposite order: analyzer, waveplate 2, waveplate 1, then reference polarizer, and rotate them counterclockwise as you face the light source. For your mosaic filter, you need to create the equivalent of that system, being careful to preserve both the order of the waveplates and the correct direction of rotation. We set this up by placing the tape squares on the face of the clear filter closer to the camera lens, first arranging all the tape 1 squares in a grid, then arranging all of the tape 2 squares on top of those, rotating all counterclockwise. Equivalently, you could place the waveplate squares on the face of the clear filter facing the light source, first arranging all the tape 2 squares in a grid, then arranging all tape 1 squares on top of those, rotating all clockwise. Either will produce the same results as the single-waveplate system.

Draw a grid on the clear filter. We found it easiest to have a guide for aligning the squares neatly in a grid on the clear filter itself. Using a ruler and a permanent marker, draw a 3×3 grid (or whatever size grid you are using), where the squares are the same size as those of the graph paper, on the clear filter.

Create a grid of tape squares. For whichever tape you are arranging first, rotate the edge of the paper/plastic guide from the $0^\circ / 180^\circ$ line to the desired angle on your angle guide and hold it steady. Using the X-Acto knife, carefully cut out a square of the tape, tracing a square of the graph paper beneath. This will create a grid square with the fast axis of the tape aligned to the proper angle. You do not need to cut all the way through the clear paper/plastic guide; in fact it is easier if you do not, since it will be easier to separate the tape from it. Using the tweezers, carefully peel off the tape square from the paper/plastic, trying to only handle the tiniest corner possible, and transfer the tape square to the grid on your clear filter. Keep track of which squares are going where on your clear filter. Repeat this process for all angles, placing each new tape square in a new grid square on the clear filter. Once all the grid squares have been filled in with one tape, move on to the next and repeat the process, placing the new tape squares on top of the previous layer.

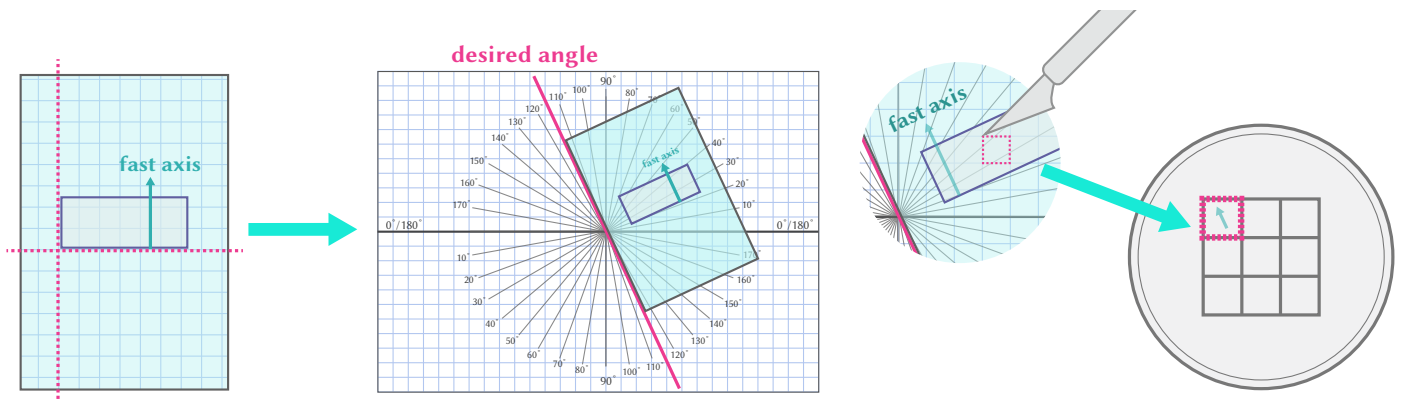

5 MEASURING REAL-WORLD REFLECTANCE SPECTRA

Materials needed:

- Prepped linear polarizers and waveplates from Sec. 2 or Sec. 4
- Digital camera: see above

Summary:

1. Set up scene.
2. Take a set of measurements of scene with the filters in chosen configurations.
3. Process results with method described in Secs. 5.2 and 5.3 of paper.

5.1 Setting the scene

Set up the camera to face your subject. We found it most effective to use an adjustable tripod for the camera. Next, screw the filters onto the camera lens, in order from the lens outward: polarizer (the “analyzer”), waveplate(s), polarizer (which we will call the “reference polarizer” to avoid confusion with the analyzer). All angles of rotation are defined relative to the 0° mark on the reference polarizer.

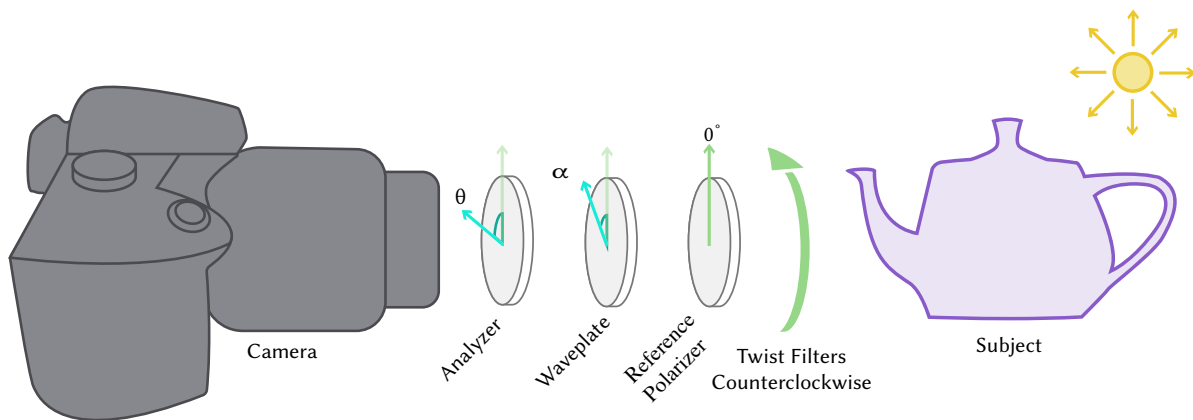

5.2 Taking measurements

Find the right exposure. See Sec. 3 for notes on exposure. Some of the filters will result in naturally darker transmission spectra than others – try to set the exposure so that no part of the scene is overexposed in the brightest photo (which should be the white balance photo, with filters aligned at 0°), yet the scene is still clearly discernible in the darkest photo (whichever filter creates the darkest transmission spectrum).

Make sure the camera is set to take RAW photos! Not JPEGs, which break the assumption of linearity in image formation.

Take a white balance photo. If using a mosaic filter for your experiment, for the white balance photo you will need to use the equivalent single-waveplate filters stacked in the same order as your mosaic squares. Align all filters to 0° . Center the Color Checker close to the center of the viewport of the camera, with as little perspective distortion as possible. We found it easiest to tape the Color Checker to a wall. Take a photo.

Take a set of measurements: single-waveplate filters. If acquiring the per-pixel spectra of a scene using single-waveplate filters, use the choice algorithm outlined in Sec. 5.1 of paper to choose an appropriate set of filters. The number of measurements to take is up to you; we found that our method reliably converged to a result using 10 measurements. For each filter configuration, rotate the waveplates and analyzer relative to the reference polarizer to the desired angles, and take a photo. There may be some chromatic aberrations toward the outer edges of the filters; try to place your subject as close to the center of the frame as possible in order to get the most accurate measurements.

Take a set of measurements: mosaic filter. If acquiring the spatially homogeneous spectrum of a single subject using a mosaic filter, use the choice algorithm outlined in Sec. 5.1 of main paper to choose an appropriate set of filters, given the constraint that the angles of the analyzer will be from 0° to 180° in increments of 10° (or however many you desire). The number of grid squares in your mosaic is again up to you; we could fit a 3×3 grid of $1/4''$ squares comfortably on our clear filter. Create the mosaic filter as described in Sec. 4. Starting at 0° and working up to 180° , rotate the analyzer to the desired angle while keeping the mosaic filter steady at 0° , and take a photo at each stage.

5.3 Processing the results

We describe the method required to process these results in detail in Secs. 5.2 and 5.3 of the main paper. Further details regarding the setup of the linear system with nonzero and smoothness constraints are described in the supplemental material of [3].

REFERENCES

- [1] J. Jiang, D. Liu, J. Gu, and S. Süsstrunk, "What is the space of spectral sensitivity functions for digital color cameras?" in *2013 IEEE Workshop on Applications of Computer Vision (WACV)*. New York, NY, USA: IEEE, 2013.
- [2] A. Beléndez, E. Fernández, J. Francés, and C. Neipp, "Birefringence of cello tape: Jones representation and experimental analysis," *European Journal of Physics*, vol. 31, no. 3, mar 2010.
- [3] S. W. Oh, M. S. Brown, M. Pollefeys, and S. J. Kim, "Do it yourself hyperspectral imaging with everyday digital cameras," in *Proc. IEEE CVPR*. New York, NY, USA: IEEE, 2016.